

***INNOVA-PRO***



BICYCLE TIRE

2026

ABOUT INNOVA

Innova Rubber Co., Ltd. was founded in 1995, headquarters in Changhua, Taiwan; factories at Taiwan and China, mainly producing bicycle tires; wheelchair tires; baby stroller tires and all kinds of leisure race tires such as ATV tires; golf cart tires; motocross tires and others.

The company aims to focus on the creation of innovation, the pursuit of quality and customer satisfaction.

Innova has an excellent R&D team and strong production bases in Taiwan and China. Our factories are all awarded ISO-9001 certification to ensure the production of the best tires/tubes and to deliver the best quality to the final consumers for the trust of customers.

Innova, pursuit of innovation is a never-ending effort, has developed a number of global patents including the new patterns, new tire structures, as well as new products.

We believe our constantly improvement in product quality and customer service will eventually make Innova become a household name synonymous with quality and value.

INNOVA-PRO



BENGBU Factory



PINGHU Office



TAIWAN Factory

## CONTENT

INNOVA ESG P03

LSR-HP TIRE P05

TPU TUBE P09

### ROAD

700C TR/TL/TT / **GLIDE** P13

700C TR / **DASH** P14

ZOOM TECH / **CASTOR** P16

ZOOM TECH / **FACEMILE** P16

700C / **HADAR** P17

700C / **NUNKI / FINCH** P18

E-CARGO  P20

E-CARGO / **MULA** P20

### E-MTB / MTB

E-MTB / **LOAM WIZARD** P22

E-MTB / **JAVELIN** P23

E-MTB / **PODIUM** P24

MTB / **BUTTE** P25

MTB / **X BOBCAT** P26

MTB / **X MUSTANG** P27

ULTRA LIGHT / **X BOBCAT** P28

MTB-DH / **SCHIST** P29

### GRAVEL

GRAVEL / **BOOTLEGGER** P31

E-GRAVEL / **EL CAMINO II** P32

GRAVEL / **STAMPEDE** P33

GRAVEL / **EL CAMINO** P34

### CITY / TREKKING / TOUR

CITY / **ROADRUNNER** P36

E-CITY / **ALTA** P37

E-CITY / **WANDERER** P38

E-CITY / **OUTPOST** P39

E-CITY / **MAKARORA** P40

E-CITY / **ATRIA** P41

E-CITY / **WANDERLUST** P42

### PLUS / FAT

FAT 4.0 & 4.8 / **GOSSAN** P43

FAT 4.0 & PLUS3.0 / **GNEISS** P44

PLUS 2.6 & 2.8 / **PODIUM** P45

PLUS 2.8 & 3.0 / **TRANSFORMERS** P46

### SNOW

SNOW / **ICE TRACKER** P48

SNOW / **ICE TRACKER II** P48

SNOW / **WIN RIDER** P48

SNOW / **WIN RIDER II** P48

SNOW / **DH MONSTER** P48

### BMX

BMX / **J-BOX** P50

BMX / **THE BIG SLICK (TBS)** P50

BMX / **WHIPLAS** P50

BMX / **TAILWHIP** P50

BMX / **MIMOSA** P50





### Environmentally friendly energy use

The use of solar power generation equipment on the factory roof can generate approximately 4.3 million kilowatt-hours of power for self-use every year, thus reducing the use of other energy sources in China factory.

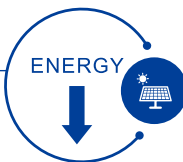

### Reduced gas emissions

INNOVA uses natural gas instead of heavy oil combustion, and the boiler carbon dioxide emissions can save 80 kg/ton per ton of steam in Taiwan and China factory.

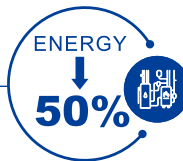

### Restore a large number of trees and sustainable organisms

Actively restore trees in the factory area to reduce carbon dioxide emissions in China factory.

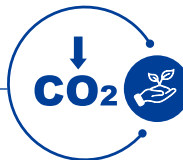

### EU New rules on deforestation

Innova will follow this rule and imported those natural rubber with the EUDR certificate for our European customers to meet the requirement of EU rule.



### Actively participate in social welfare activities

INNOVA donate scholarships for poor students, sponsor school bike teams, happy children's angel cycling activities, and organize bicycle races.



### Material recycling

INNOVA use recycled fishing nets to make tire casing + recycled carbon black + recycled rubber + carbon black-free formula in Taiwan and China factory .

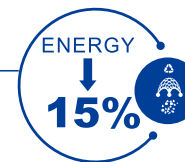

### Energy-saving ventilation equipment

INNOVA uses environmentally friendly ventilation equipment for rest and standby, which can save 17% of electricity every month in Taiwan and China factory .

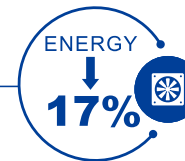

### Production equipment energy-saving system

Extruders, air compressors, and other related equipment in the factory all use variable frequency voltage systems, which can save about 50% of electricity every month in Taiwan and China factory.



### Reduce petroleum materials

Soy bean oil to replace the existing petroleum process oil + silica powder to replace carbon black formula in Taiwan and China factory .



### Corporate Governance

The business philosophy and company culture are clear, and the operation and governance are transparent. Two operating meetings, board meetings and one shareholders meeting are held every year. The company also formulates short, medium and long-term development plans in line with various international management indicators and market needs.



# LSR-HP TIRE

Low profile radial tire with wider rim

Patent pending



TAIPEI CYCLE  
d&i awards 2025

by ifc

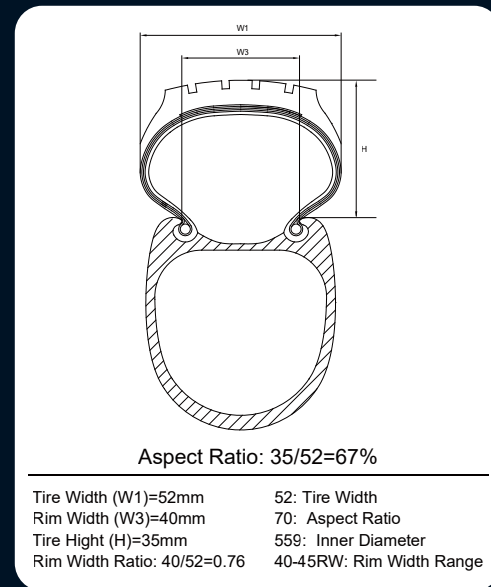

- The LSR-HP tires is low profile radial tire to reach high performance and supple ride experience.
- Like car tires, the aspect ratio is lower for better performance and the specified rim width range are designed to match the performance.
- New size will be "tire width/aspect ratio-inner diameter rim width " 65/70-584 50-55RW & 52/70-559 40-45RW "

EX: " 52/70-559 40-45RW "

Tire Width

Aspect Ratio

Rim Width Range

Inner Diameter

## DIMENSION

LSR-HP tires

VS.

Traditional tires

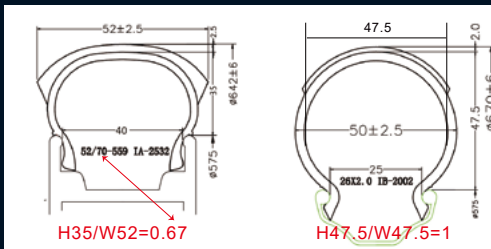

## CONTACT AREA

LSR-HP tires

VS.

Traditional tires

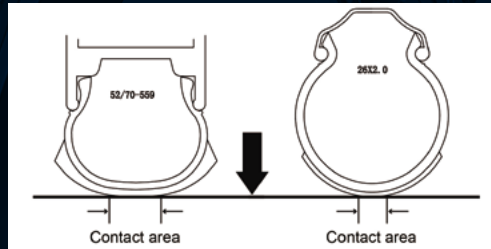



Patent pending

# LSR-HP TIRE

Low profile radial tire with wider rim

65/70-584 50-55RW



LSR-HP	PATTERN	ETRTO	RIM	TT	CASING	PSI	Weight ± 5%(g)	Part. No.
65/70-584 50-55RW	IB-3031LSR	65/70-584	50/55-584	TLR	60	50 MAX	TBA	LSR6558401



# LSR-HP TIRE



52/70-559 40-45RW



LSR-HP	PATTERN	ETRTO	RIM	TT	CASING	PSI	Weight ± 5%(g)	Part. No.
52/70-559 40-45RW	IA-2085LSR	52/70-559	40/45-559	TT	60	50 MAX	510	LSR5255901
52/70-559 40-45RW	IA-2532LSR	52/70-559	40/45-559	TT	60	50 MAX	510	LSR5255902



## INNOVA TPU TUBE TECHNOLOGY

Innova Creates Two Different Type Tpu Tubes:

- ★ SHEET TYPE IS FOR PLUS AND FAT TIRES
- ★ EXTRUSION TYPE FOR ROAD/GRAVEL/MOUNTAIN BIKE TIRES

# INNOVA-PRO TPU BICYCLE TUBE

TPU Tubes Provide Those Advantages Including:

- **LIGHTER WEIGHT:** 60% LIGHTER THAN BUTYL TUBE
- **SMALLER VOLUME:** 50% VOLUME OF BUTYL TUBE
- **BETTER ANTI-PUNCTURE:** 5 TIMES STRONGER AT THE SAME THICKNESS
- **BETTER AIR HOLDING:** 4 TIMES BETTER AT THE SAME THICKNESS
- **BETTER SAFETY:** 5 TIMES STROGER SPLICE STRENGTH
- **100% RECYCLE**



INNOVA-PRO TPU 20X1.75/2.5 47/64-406 MADE IN TAIWAN TAK270001



60mm  
Presta

## SUSTAINABILITY

TPU tubes are the new generation to help the earth better and also up-grade the tube quality to make bike lighter.

- Much friendly to environment.
- More performances.
- Much safety

Sizes	Vales	Weight ± 5%(g)	PART NO.
700X18/28C (18/28-622)	SV48	42	TPU622F101
700X18/28C (18/28-622)	SV60	43	TPU622F201
700X25/35C (25/35-622)	SV48	57	TPU622F102
700X25/35C (25/35-622)	SV60	58	TPU622F202
700X25/35C (25/35-622)	SV48 Removable	50	TPU622G101
700X38/52C (38/52-622)	SV48	81	TPU622F103
700X38/52C (38/52-622)	SV60	83	TPU622F203
29X1.75/2.5 (47/64-622)	SV48	85	TPU622F104
27.5X1.75/2.5 (47/64-584)	SV48	81	TPU584F101
26X1.75/2.5 (47/64-559)	SV48	79	TPU559F101
20X1.75/2.5 (47/64-406)	SV48	61	TPU406F101
29X1.75/2.5 (47/64-622)	SV60	85	TPU622F200

# ANTI PUNCTURE

Innova protection system for puncture & cut proof

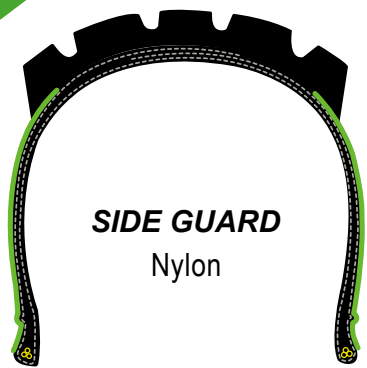

**SIDE GUARD**  
Nylon



**FULL GUARD**  
Nylon



**SUPER GUARD**  
For E-Cargo



**CAP GUARD**  
Nylon

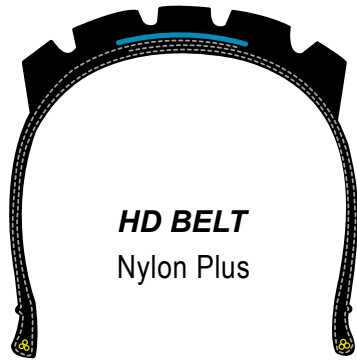

**HD BELT**  
Nylon Plus

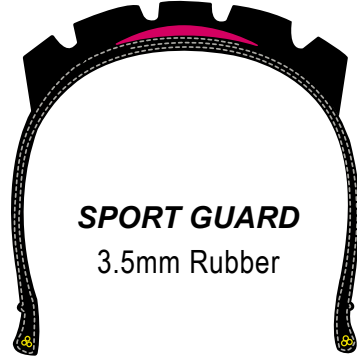

**SPORT GUARD**  
3.5mm Rubber

# CLASS

## TLR TUBELESS READY

TUBELESS READY tires can be used as regular tire with tube inside but also can be used as tubeless tire by adding sealant inside. Tubeless ready has similar function as UST tire but owns double functions of excellent puncture resistance and lighterweight for superior rolling as well as handling performance. Adding sealant is necessary.

## TEAM

TEAM is the most high end tires that Innova produces for competition. The feature of Team is designed by using 120 tpi casing with foldable Kevlar bead for most light weight and special tread compound gives highest performance tires.

## RACE

RACE tires is these excellent tire that Innova pro design for Race and final training for competition. By using 60 tpi casing with foldable Kevlar bead, this class owns the features of light weight and powerful performance.

## STANDARD

STANDARD tires is most economic tire with the rigid bead and 60tpi casing. It shows very even distribution of stress after inflation and gives pretty good uniformity as well as good tire life.



SNAKE BITE

The function of Anti Snake Bite is designed by adding strongest fillers in the bead area to prevent the snake bite. The weight is added but perfectly suitable for those Down Hill tires requesting to free from snake bite.

# CASING & BEAD

## FOLDING BEAD

**FOLDING BEAD**  
Innova uses DuPont™ Kevlar® yarn as the material of bead grommet. This high quality material provides the most light weight foldable tire for team and race class.

## 60 TPI

Nylon 66 fabric with 60 threads per inch(tpi) which is designed for the race and training version.

## 120 TPI

Nylon 66 fabric with 120 threads per inch(tpi) which is designed for the race and training version.

## 180 TPI

Nylon 66 fabric with 180 threads per inch(tpi) which is designed for the race and training version.

## HIGH PERFORMANCE ROAD TIRE

### GLIDE

- Strongest Anti-Puncture by HD Belt
- Longer life + high grip by high grip silica compound
- Smoother riding by glide pattern design



IB-3029N **FOLDING**

CLASS	SIZE	ETRTO	CASING	HOOKLESS(Psi)	HOOKLESS(BAR)	HOOKED(Psi)	HOOKED(BAR)	PART NO.
TL (TUBELESS)	700x25C	25-622	120TPI	Max.72	Max.5.0	90-110	6.2-7.5	RO7002501
	700x28C	28-622	120TPI	Max.72	Max.5.0	85-100	6.0-6.8	RO7002801
	700x30C	30-622	120TPI	Max.65	Max.4.5	80-95	5.5-6.5	RO7003001
TLR (TUBELESS READY)	700x25C	25-622	120TPI	Max.72	Max.5.0	90-110	6.2-7.5	RO7002502
	700x28C	28-622	120TPI	Max.72	Max.5.0	85-100	6.0-6.8	RO7002802
	700x30C	30-622	120TPI	Max.65	Max.4.5	80-95	5.5-6.5	RO7003002
TT	700x25C	25-622	120TPI	*****	*****	90-110	4.8-7.5	RO7002503
	700x28C	28-622	120TPI	*****	*****	85-100	4.7-6.5	RO7002803
	700x30C	30-622	120TPI	*****	*****	80-95	3.8-5.5	RO7003003

▲ TL for TUBELESS rim only

▲ TLR adding tire sealant is necessary

## DASH

700x30C the wider road tire provides more comfort riding and lower rolling resistance. The unique antled-cut tread works like a file, giving you excellent grip while keeping a fast and confidence surfaces. With slick center design, the smoother the faster.

### TLR

TUBELESS READY

TLR 60  
TUBELESS READY

TLR 120  
TUBELESS READY



IB-3015N

**FOLDING**

CLASS	SIZE	ETRTO	CASING	WEIGHT	PSI	BAR	PART NO.
TLR 60 (TUBELESS READY)	700x25C	25-622	60TPI	TBA	90-110	6.2-7.5	DA7002501
	700x28C	28-622	60TPI	TBA	85-100	6.0-6.8	DA7002801
	700x30C	30-622	60TPI	369	70-90	4.9-6.2	DA7003001
TLR 120 (TUBELESS READY)	700x25C	25-622	120TPI	TBA	TBA	TBA	DA7002502
	700x28C	28-622	120TPI	TBA	TBA	TBA	DA7002802
	700x30C	30-622	120TPI	342	70-90	4.9-6.2	DA7003002



# Zoom Tech

**Low Rolling Resistance / Light Weight / Supple Riding / Faster Acceleration**

**Z:** Zero degree nylon' belt is added under the tread to provide a super low rolling resistance.

**O:** Open tire profile to provide extremely high ride comfort.

**O:** Overlap dual new compounds to obtain best performances of grip and life.

**M:** Mono-chafer: new chafer material helps to have the best adhesion and anti-leaking

Grip	★★★★★
Rolling Resistance	★★★★★
Acceleration	★★★★☆
Comfort	★★★★★
Cornering	★★★★★

700  
23C700  
25C700  
27C

- Super high quality tire that developed by the technology of "ZOOM" intending to compete with Tubular tire in competition.
- Made of 120Tpi casing with those following sizes of 23C/25C/27C.
- The air pressure can go up to 145 Psi.



## CASTOR

IA-2321

FOLDING

SIZE	ETRTO	CASING	WEIGHT	PSI	BAR	PART NO.
700x23C	23-622	120TPI	226	100-145	6.8-10.0	CA7002301
700x25C	25-622	120TPI	235	100-135	6.8-9.3	CA7002501
700x27C	27-622	120TPI	258	80-115	5.5-8.0	CA7002701



## FACEMILE

IA-2322

FOLDING

SIZE	ETRTO	CASING	WEIGHT	PSI	BAR	PART NO.
700x23C	23-622	120TPI	226	100-145	6.8-10.0	FA7002301
700x25C	25-622	120TPI	235	100-135	6.8-9.3	FA7002501
700x27C	27-622	120TPI	258	80-115	5.5-8.0	FA7002701

### HADAR



IA-2319

- 700  
23C
- 700  
25C
- 700  
28C

**FOLDING**

CLASS	SIZE	ETRTO	CASING	WEIGHT	PSI	BAR	PART NO.
TEAM	700x23C	23-622	120TPI	195	100-130	6.0-10.0	HA7002301
	700x25C	25-622	120TPI	224	86-100	6.0-9.0	HA7002501
	700x28C	28-622	120TPI	247	60-100	6.0-7.5	HA7002801
RACE	700x23C	23-622	60TPI	212	100-130	6.0-10.0	HA7002302
	700x25C	25-622	60TPI	241	86-100	6.0-9.0	HA7002502
	700x28C	28-622	60TPI	274	60-100	6.0-7.5	HA7002802

### NUNKI



IA-2318

- 700  
23C
- 700  
25C
- 700  
28C

**FOLDING**

CLASS	SIZE	ETRTO	CASING	WEIGHT	PSI	BAR	PART NO.
TEAM	700x23C	23-622	120TPI	195	100-130	7.0-9.0	NU7002301
	700x25C	25-622	120TPI	208	86-110	6.0-7.7	NU7002501
	700x28C	28-622	120TPI	TBA	TBA	TBA	NU7002801
RACE	700x23C	23-622	60TPI	213	100-130	7.0-9.0	NU7002302
	700x25C	25-622	60TPI	229	86-110	6.0-7.7	NU7002502
	700x28C	28-622	60TPI	TBA	TBA	TBA	NU7002802

### FINCH



IA-2165

- 700  
25C
- 700  
28C

**FOLDING**

CLASS	SIZE	ETRTO	CASING	WEIGHT	PSI	BAR	PART NO.
TEAM	700x25C	25-622	120TPI	220	86-100	6.0-7.7	FL7002501
	700x28C	28-622	120TPI	224	60-100	4.1-6.8	FL7002801



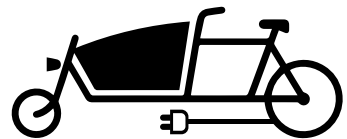

## E-CARGO

*Special 6 ply tire construction not only increase the sidewall stiffness, but also provide enhance puncture protection.*

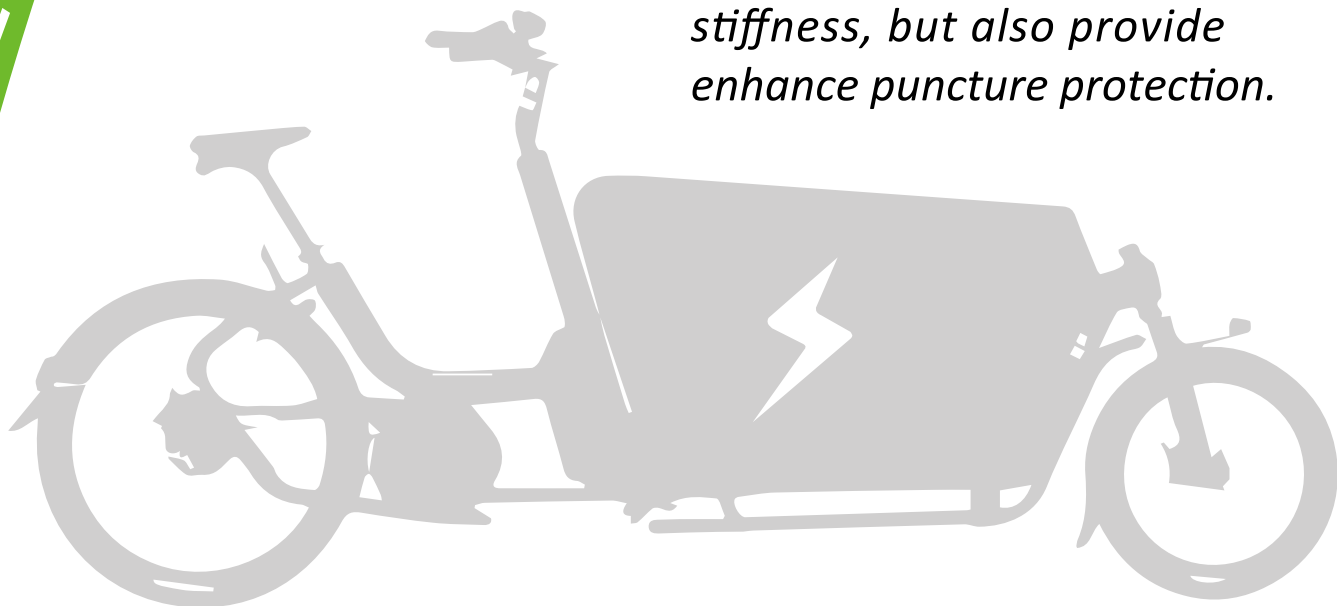

## MULA

Mula is our newest Cargo specific bike tire. The casing structure and rubber compound is designed specifically for loaded towing. Specific inserts are used to prevent puncture and increase durability. The tread design utilize a continous center block ribbed section and a diamond shapped side knobs to allow for secure cornering and towing capability.

### INTENDED SURFACE

Bike path, sidewalks, unpaved path and gravel.



### IB-3027

						RIGID
SIZE	ETRTO	CASING	WEIGHT	PSI	BAR	PART NO.
20x2.40	62-406	60TPI	990	25-50	1.7-3.5	E50M20241
24x2.40	62-507	60TPI	1235	25-50	1.7-3.5	E50M24241
26x2.40	62-559	60TPI	1360	25-50	1.7-3.5	E50M26241
27.5x2.40	62-584	60TPI	1420	25-50	1.7-3.5	E50M27524

# MTB



## LOAM WIZARD

Designed for All Mountain and Enduro riding. On the uphill, the large center block provides improved climbing traction, and quick acceleration. The links between the center block makes the pattern block more stable under load and reduce squirming. The directional design on the tread allows for significant reductions in tire rolling resistance. The combination of aggressive arrangement of the blocks, open design and a simple V-slot located in the center and side blocks translate to direct and precise steering. It allow for a high efficient transfer of power to the ground while maintaining extreme durability.

TLR 60  
TUBELESS READY

**E-50**  
With Reflective Stripe /  
Sport Guard-3.5mm+ Side Guard



### IB-3021N

CLASS	SIZE	ETRTO	CASING	WEIGHT	PSI	BAR	PART NO.	FOLDING	
								TAN	SPEC.
RACE+TLR	29x2.35	60-622	60TPI	828	35-65	2.4-4.5	LW2923501	LW2923501T	
E BIKE-50+TLR	29x2.35	60-622	60TPI	1025	25-50	1.7-3.5	E50L29235	E50L29235T	

# JAVELIN

Designed as a leading off-road road conditions and ultra-endurance tires. The unwavering traction of the shoulder knobs, and the super handling when going downhill. This is the preferred tyre for our entire endurance team of endurance racers due to its unmatched traction on off-camber trails. The interspersed central pattern blocks can bite into the dirt in any wet or dry terrain while providing stability at any speed. The block are arranged in a way to ensure effective mud clearance. It can also be used as a rear tire on loose, steep terrain for its strong braking traction. It can also be used as a front tire for its cornering capability.



TLR 60  
TUBELESS READY



With Reflective Stripe /  
Sport Guard-3.5mm+ Side Guard

IB-3022

FOLDING

CLASS	SIZE	ETRTO	CASING	WEIGHT	PSI	BAR	PART NO.	TAN SPEC.
RACE+TLR	29x2.35	60-622	60TPI	820	35-65	2.4-3.5	JA2923501	JA2923501T
E BIKE-50+TLR	29x2.35	60-622	60TPI	1030	25-50	1.7-3.5	E50J29235	E50J29235T

# PODIUM

27.5x2.6 PODIUM For fast E-bikes, Innova has designed the special tire construction and compound. The premium compound offers the dependability of excellent grip & high mileages and the construction of Sport Guard 3.5mm & Side Guard provides the superior puncture protection. It was certified with ECE-R75 and approved for vehicles, up to 50 km/h. An all terrain pattern design with the tubeless ready construction. Aggressive outlook plus the design of small lines insert into each knob give the tire powerful performances in riding.



RACE

TLR 60  
TUBELESS READY



With Reflective Stripe /  
Sport Guard-3.5mm+ Side Guard

IB-3014N

FOLDING

CLASS	SIZE	ETRTO	CASING	WEIGHT	PSI	BAR	PART NO.
E BIKE-50+TLR	27.5x2.60	66-584	60TPI	1345	20-45	1.4-3.1	PO2752601
RACE+TLR	27.5x2.60	66-584	60TPI	852	30-60	2.1-4.2	E50P27526
RACE	26x2.25	58-559	60TPI	745	30-60	2.1-4.2	PO2622501
	27.5x2.25	58-584	60TPI	768	35-65	2.4-4.5	PO2752251
	29x2.25	58-622	60TPI	816	35-65	2.4-4.5	PO2922501
	29x2.40	60-622	60TPI	833	35-65	2.4-4.5	PO2924001

## BUTTE

Pattern Design with separator knobs is good for mud performance. Tire is foldable and easy to carry. Suitable for use on road or hard soil territory.

TLR 60  
TUBELESS READY



IB-3011

CLASS	SIZE	ETRTO	CASING	WEIGHT	PSI	BAR	PART NO.	FOLDING
								TAN SPEC.
RACE	27.5x2.25	58-584	60TPI	606	30-65	2.1-4.5	BU2752251	BU2752251T
RACE + TLR	29x2.25	58-622	60TPI	643	30-65	2.1-4.5	BU2922501	BU2922501T

## X BOBCAT

The tread pattern is designed for multiple soil conditions. Low tread profile and high TPI casing give fast rolling and efficient.

RACE

TLR 60  
TUBELESS READY



IB-2003

CLASS	SIZE	ETRTO	CASING	WEIGHT	PSI	BAR	PART NO.	FOLDING
RACE	26x2.10	54-559	60TPI	512	30-60	2.1-4.2	XB2621001	
	27.5x2.10	54-584	60TPI	602	30-60	2.1-4.2	XB2752101	
	29x2.10	54-622	60TPI	647	30-60	2.1-4.2	XB2921001	
RACE + TLR	27.5x2.10	54-584	60TPI	558	30-60	2.1-4.2	XB2752102	
	29x2.10	54-622	60TPI	599	30-60	2.1-4.2	XB2921002	



# X MUSTANG

Light-weight tread design allow maximum rolling efficiency. Suitable for road and hard terrain with few sand and small rocks.

RACE



IB-2002

FOLDING

CLASS	SIZE	ETRTO	CASING	WEIGHT	PSI	BAR	PART NO.
RACE	26x2.0	50-559	60TPI	491	35-70	2.5-5.0	XM2621001
	27.5x2.10	54-584	60TPI	537	35-70	2.4-4.8	XM2752101

# MTB ULTRA LIGHT

## X BOBCAT

The tread pattern is designed for multiple soil conditions. Low tread profile and high TPI casing give fast rolling and efficient. Ultra light weight and foldable tire is easily to carry.

TEAM  
ULTRA LIGHT

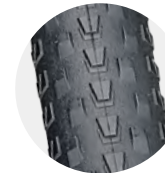

IB-2003L

FOLDING

CLASS	SIZE	ETRTO	CASING	WEIGHT	PSI	BAR	PART NO.
TEAM + ULTRA LIGHT	26x1.95	44-559	120TPI	318	30-60	2.1-4.2	XBL261951
	27.5x1.95	44-584	120TPI	324	30-60	2.1-4.2	XBL275195
	29x1.95	44-622	120TPI	355	30-60	2.1-4.2	XBL291951
	29x2.10	54-622	120TPI	428	30-60	2.1-4.2	XBL292101

MTB TIRES

# SCHIST

The tread pattern is designed for multiple soil conditions. Low tread profile and high TPI casing give fast rolling and efficient.

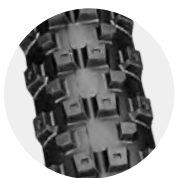

IB-3004

**FOLDING**

SIZE	ETRTO	CASING	WEIGHT	PSI	BAR	PART NO.
26x2.50	62-559	60TPI	981	20-65	1.4-4.5	SH2625001
27.5x2.50	62-584	60TPI	1029	20-65	1.4-4.5	SH2752501
29x2.40	60-622	60TPI	1099	25-50	1.7-3.5	SH2924001

★ With Snake Bite & Side Guard

For Downhill Bike



Snake Bite



MTB

# GRAVEL

TIRE >>>





## BOOTLEGGER

Bootlegger incorporate a semi slick concept to allow for fast rolling on pavement while maintaining grip when the trail get loose. It's best suited mixed terrain.

RACE



IB-3028

FOLDING

CLASS	SIZE	ETRTO	CASING	WEIGHT	PSI	BAR	PART NO.
RACE	29x1.75	45-622	60TPI	571	40-65	2.75-4.5	BO2917501

## EL CAMINO II

The smooth tread center can roll very quickly on paved road. The diamond shaped intermediate transition tread make sure this tire won't be stopped by any rough roads and long detours.

It allow for strong confidence in any road condition, providing a smooth riding experience, and maintaining good handling on unpredictable terrain with the square pattern of the tread shoulder. Suitable for riders who want to relax themselves without a destination , just for the pleasure of riding.

RACE

TLR 60  
TUBELESS READY

**E-25**

With Reflective Stripe /  
Sport Guard-3.5mm

**E-50**

With Reflective Stripe /  
Sport Guard-3.5mm+ Side Guard



IB-3018

FOLDING

CLASS	SIZE	ETRTO	CASING	WEIGHT	PSI	BAR	PART NO.	TAN SPEC.
RACE	700x38C	38-622	60TPI	401	50-75	3.4-5.1	EC7003801	EC7003801T
E BIKE-50+TLR	700x38C	38-622	60TPI	730	35-65	2.4-4.5	E50E70038	E50E70038T

CLASS	SIZE	ETRTO	CASING	WEIGHT	PSI	BAR	PART NO.	RIGID
E BIKE-25	700x38C	38-622	33TPI	821	50-75	3.4-5.1	E25O70038	E25O70038T

# STAMPEDE

Gravel Tire but also works well for road condition due to the high density knobs parent design. Shoulder design with more convex knobs enhanced the grip for better turning performance and safety. Tire is foldable and easy to carry. Suitable for use on road or hard soil territory.

RACE



IB-3010

FOLDING

CLASS	SIZE	ETRTO	CASING	WEIGHT	PSI	BAR	PART NO.
RACE	26x1.50	40-559	60TPI	391	50-75	3.5-5.0	ST2615001
	700x40C	40-622	60TPI	441	50-75	3.5-5.0	ST7004001
	700x45C	45-622	60TPI	465	50-75	3.5-5.0	ST7004501
	700x50C	60-622	60TPI	495	50-75	3.5-5.0	ST7005001

# EL CAMINO

For a gravel tire, you want a tire that is able to cover riding on variety of different surfaces and conditions. The tire should provide grip while rolling smoothly. This is exactly what the tire is able to do. You will find it to perform well on paved roads but it really shine on unpaved roads and gravel. Riding on dry conditions light trails is also a lot of fun. For slightly more muddy conditions the aggressive side knobs maintain the traction effectively. The smooth ride and good grip let you enjoy every meter of your commutes and rides.

RACE



IB-3016

FOLDING

CLASS	SIZE	ETRTO	CASING	WEIGHT	PSI	BAR	PART NO.	TAN SPEC.
RACE	26x1.75	47-559	60TPI	435	30-55	2.1-3.8	EC2617501	EC2617501T
	700x45C(29x1.75)	45-622	60TPI	571	30-60	2.0-4.1	EC7004501	EC7004501T
	650Bx47C	47-584	60TPI	571	55	2.1-3.8	EC6504701	EC6504701T

GRAVEL



# CITY / TREKKING / TOURING >>>



**E-50**

With Reflective Stripe  
Sport Guard-3.5mm  
+ Side Guard

**E-25**

With Reflective Stripe  
Sport Guard-3.5mm

## ROADRUNNER

Roadrunner is our newest Trekking / Touring specific tire. The unique tire tread incorporate directional siping to improve traction in the wet. We also added honeycomb sidewall pattern increase abrasion resistance.

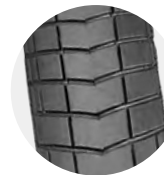
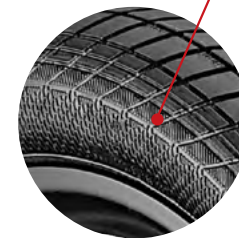

IB-3023

**FOLDING**

CLASS	SIZE	ETRTO	CASING	WEIGHT	PSI	BAR	PART NO.
RACE	26x1.75	47-559	60	TBA	30-60	2.1-4.1	RO2617501
	700x45C	45-622	60	TBA	30-60	2.1-4.1	RO7004501



## WANDERER

Wanderer is a modern dynamic touring tire. The center tread is smooth and side knob-designed for nimble handling. The tread allow for fast rolling on pavement, while maintain superior traction on unpaved path. New high tech compound is used to optimize this tire to have superior durability at high speed and low rolling resistance.



With Reflective Stripe /  
Sport Guard-3.5mm



With Reflective Stripe /  
Sport Guard-3.5mm+ Side Guard



### IB-3026

							FOLDING
CLASS	SIZE	ETRTO	CASING	WEIGHT	PSI	BAR	PART NO.
RACE	29x2.15	55-622	60TPI	695	30-60	2.0-4.1	WA2921501
E BIKE-50	29x2.15	55-622	60TPI	760	30-60	2.0-4.1	E50W29215
							RIGID
E BIKE-25	29x2.15	55-622	33TPI	1245	30-60	2.0-4.1	E25W29215

## OUTPOST

The continuous straight tread pattern in the center allows for a lower rolling resistance for charging down the straights, while a bi-textured surface designs on the sides treads are used to improve the handling in cornering. Built for the mixed pavement and light gravel.



IB-3019

**FOLDING**

CLASS	SIZE	ETRTO	CASING	WEIGHT	PSI	BAR	PART NO.	TAN SPEC.
RACE	700x35C	35-622	60TPI	390	55-80	3.8-5.5	OU7003501	OU7003501T
	700x38C	38-622	60TPI	457	50-75	3.4-5.1	OU7003801	OU7003801T
	26x2.0	50-559	60TPI	580	35-65	2.4-4.5	OU2620001	OU2620001T
	27.5x2.10	54-584	60TPI	625	30-60	2.1-4.1	OU7003801	OU7003801T
E BIKE-50	700x38C	38-622	60TPI	TBA	50-75	3.4-5.1	E50070038	E50070038T
	27.5x2.10	54-584	60TPI	970	30-60	2.1-4.1	E50027521	E50027521T

**RIGID**

E BIKE-25	700x38C	38-622	33TPI	946	50-75	3.5-5.0	E25070038	E25070038T
	27.5x2.10	54-584	33TPI	1349	35-65	2.1-4.5	E25027521	E25027521T

RACE



With Reflective Stripe / Sport Guard-3.5mm



With Reflective Stripe / Sport Guard-3.5mm+ Side Guard

## MAKARORA

Featuring an ultra-dynamic large bevel profile with a smooth center section and a sturdy diamond side tread. Even on unpaved gravel road, it can roll easily on the road and have maintain strong grip. The specially optimized design provides maximum durability, low rolling resistance and excellent gripeven at high speeds.

RACE



With Reflective Stripe / Sport Guard-3.5mm



With Reflective Stripe / Sport Guard-3.5mm+ Side Guard



IB-3020

**FOLDING**

CLASS	SIZE	ETRTO	CASING	WEIGHT	PSI	BAR	PART NO.	TAN SPEC.
RACE	700x42C	42-622	60TPI	461	50-75	3.4-5.1	MA7004201	MA7004201T
E BIKE-50	700x42C	42-622	60TPI	TBA	50-75	3.4-5.1	E50M70042	E50M70042T

**RIGID**

E BIKE-25	700x42C	42-622	33TPI	895	50-75	3.4-5.1	E25M70042	E25M70042T
-----------	---------	--------	-------	-----	-------	---------	-----------	------------

**CITY / TREKKING**  
**/ TOURING**

## ATRIA

TEAM

RACE



With Reflective Stripe  
/ Sport Guard-3.5mm



IA-2562

**FOLDING**

CLASS	SIZE	ETRTO	CASING	WEIGHT	PSI	BAR	PART NO.
TEAM	26x2.0	50-559	120TPI	405	35-65	2.4-4.5	AT2620001
	26x2.0	50-559	60TPI	441	35-65	2.4-4.5	AT2620002
	27.5x2.0	50-584	60TPI	498	30-60	2.1-4.2	AT2752001
RACE	700x32C	32-622	60TPI	359	60-90	4.1-6.5	AT7003201
	700x35C	37-622	60TPI	389	50-90	3.4-6.2	AT7003501
	700x38C	40-622	60TPI	439	50-90	3.4-6.2	AT7003801
	700x44C	44-622	60TPI	479	40-70	2.8-4.9	AT7004401

**RIGID**

CLASS	SIZE	ETRTO	CASING	WEIGHT	PSI	BAR	PART NO.
E BIKE-25	700x38C	40-622	33TPI	TBA	50-80	3.5-5.5	E25A700381
	700x44C	44-622	33TPI	TBA	45-80	3.1-5.5	E25A700441

## WANDERLUST

TEAM

RACE



With Reflective Stripe /  
Sport Guard-3.5mm+ Side Guard



With Reflective Stripe  
/ Sport Guard-3.5mm



IB-3013

**FOLDING**

CLASS	SIZE	ETRTO	CASING	WEIGHT	PSI	BAR	PART NO.	TAN SPEC.
TEAM	26x1.75	47-559	120TPI	404	40-65	2.8-4.5	WA2617501	WA2617501T
	27.5x1.75	47-584	120TPI	424	40-65	2.4-4.5	WA2751751	WA2751751T
	29x1.75	47-622	120TPI	449	40-65	2.4-4.5	WA2917501	WA2917501T
RACE	700x38C	38-622	60TPI	431	50-75	3.5-5.0	WA7003801	WA7003801T
E BIKE-50	700x38C	38-622	60TPI	TBA	50-75	3.5-5.0	E50W70038	E50W70038T

**RIGID**

E BIKE-25	700x38C	38-622	33TPI	860	50-75	3.5-5.0	E25W70038	E25W70038T
-----------	---------	--------	-------	-----	-------	---------	-----------	------------

**CITY / TREKKING**  
**/ TOURING**

# GOSSAN

The new particle pattern design is with great center pieces and low knobsles. It is good for both on road and off road condiction. Very good grip for off road and very stable for turning.

RACE

FAT 4.0

FAT 4.8



LV-1008

**FOLDING**

CLASS	SIZE	CASING	WEIGHT	PSI	BAR	PART NO.
RACE	26x4.0	60TPI	1065	5-15	0.4-1.1	GO2640001
	26x4.8	60TPI	1305	MAX30	2.1	G02648001

# GNEISS

Dense central knobs to get an excellent performance of easy rolling and comfort ride ; the tread shoulder area is designed with loose knobs to earn great traction in cornering as well as steady handling.

PLUS 3.0

FAT 4.0



LV-1003

**FOLDING**

CLASS	SIZE	CASING	WEIGHT	PSI	BAR	PART NO.
TEAM	27.5x3.0	120TPI	865	15-30	1.1-2.1	GN2753001
RACE	26x4.0	60TPI	1255	5-15	0.4-1.1	GN2640001

**FAT**  
PLUS 2.6 / 2.8

## PODIUM

PLUS 2.6

PLUS 2.8

The premium compound offers the dependability of excellent grip & high mileages and the construction of Sport Guard 3.5mm & Side Guard provides the superior puncture protection. It was certified with ECE-R75 and approved for vehicles, up to 50 km/h. An all terrain pattern design with the tubeless ready construction. Aggressive outlook plus the design of small lines insert into each knob give the tire powerful performances in riding.



IB-3014

**FOLDING**

CLASS	SIZE	ETRTO	CASING	WEIGHT	PSI	BAR	PART NO.
RACE	26x2.8	70-559	60TPI	910	15-35	1.1-2.4	PO2628001
	27.5x2.8	70-584	60TPI	960	15-35	1.1-2.4	PO2752801
E BIKE-50	26x2.8	70-559	60TPI	1200	20-45	1.4-3.1	E50P26281
	27.5x2.8	70-584	60TPI	1250	20-45	1.4-3.1	E50P27528

**RIGID**

CLASS	SIZE	ETRTO	CASING	WEIGHT	PSI	BAR	PART NO.
	20x2.6	66-406	33TPI	690	15-35	1.1-2.4	E25P20261
	20x2.8	70-406	33TPI	740	15-35	1.1-2.4	E25P20281
E BIKE-25	24x2.8	70-507	33TPI	930	15-35	1.1-2.4	E25P24281
	26x2.8	70-559	33TPI	1020	15-35	1.1-2.4	E25P26281
	27.5x2.8	70-584	33TPI	1065	15-35	1.1-2.4	E25P27528

## TRANSFORMERS

An all terrain design by using many small knobs obtains the comfortable ride and smooth handle control. Also the design of holes in center of each knob is designed give more contact area with road surface to earn the best traction.

PLUS 2.8

PLUS 3.0



IA-2569

**FOLDING**

CLASS	SIZE	CASING	WEIGHT	PSI	BAR	PART NO.
RACE	27.5x2.8	60TPI	780	15-35	1.1-2.4	TR2752801
	29x3.0	60TPI	905	15-30	1.1-2.1	TR2930001

PLUS 2.8 / 3.0  
**FAT**





# SNOW tires



Aluminum studs with tungsten carbide pins



## Aluminum studs with tungsten carbide pins

**FOLDING**

NAME	PATTERN	SIZE	ETRTO	CASING(TPI)	WEIGHT	PSI	BAR	STUDES	PART NO.
ICE TRACKER	IA-2901	26x2.10	54-559	60TPI	810g	35-65	2.4-4.5	268	IT2621001
WIN RIDER	IA-2902	700x38C	40/44-622	60TPI	600g	50-75	3.4-5.1	110	WR7003801
ICE TRACKER II	IA-2572	29x2.10	54-622	60TPI	815g	35-65	2.4-4.5	184	ITII292101
ICE TRACKER II	IA-2572	27.5x2.10	54-584	60TPI	765g	35-65	2.4-4.5	184	ITII275211
WIN-RIDER II	IA-2573	29x2.10	54-622	60TPI	815g	35-65	2.4-4.5	300	WRII292101
DH MONSTER	IA-2570	26x2.35	58-559	60TPI	820g	35-65	2.4-4.5	312	DH2623501
DH MONSTER	IA-2570	27.5x2.35	58-584	60TPI	870g	35-65	2.4-4.5	324	DH2752351



Steel studs with tungsten carbide pins



## Steel studs with tungsten carbide pins

**FOLDING**

NAME	PATTERN	SIZE	ETRTO	CASING(TPI)	WEIGHT	PSI	BAR	STUDES	PART NO.
ICE TRACKER	IA-2901	26x2.10	54-559	33TPI	870g	35-65	2.4-4.5	268	ITS262101
WIN RIDER	IA-2902	700x38C	40/44-622	33TPI	645g	50-75	3.4-5.1	110	WRS700381
ICE TRACKER II	IA-2572	29x2.10	54-622	33TPI	885g	35-65	2.4-4.5	184	ITIIS29211
ICE TRACKER II	IA-2572	27.5x2.10	54-584	33TPI	820g	35-65	2.4-4.5	184	ITIIS27521
WIN-RIDER II	IA-2573	29x2.10	54-622	33TPI	885g	35-65	2.4-4.5	300	WRIIS29211
DH MONSTER	IA-2570	26x2.35	58-559	33TPI	880g	35-65	2.4-4.5	312	DHS262351
DH MONSTER	IA-2570	27.5x2.35	58-584	33TPI	930g	35-65	2.4-4.5	324	DHS275235

SNOW TIRE

# BMX TIRES



**THE BIG SLICK  
(TBS)**

**J-BOX**

**WHIPLASH**

**TAILWHIP**

**MIMOSA**



## THE BIG SLICK(TBS) IB-3009

SIZE	ETRTO	CASING	WEIGHT	PSI	BAR	PART NO.	BEAD
20x2.3	58-406	60TPI	595	110	7.6	TBS202301	FOLDING
20x2.3	58-406	60TPI	645	110	7.6	TBS202302	RIGID
20x2.4	60-406	60TPI	710	110	7.6	TBS202401	FOLDING
20x2.4	60-406	60TPI	770	110	7.6	TBS202402	RIGID

## J-BOX IB-2005

SIZE	ETRTO	CASING	WEIGHT	PSI	BAR	PART NO.	BEAD
20x2.2	56-406	60TPI	425	60-110	4.2-7.8	JB2022001	FOLDING

## WHIPLASH IA-2248

SIZE	ETRTO	CASING	WEIGHT	PSI	BAR	PART NO.	BEAD
20x2.0	50-406	60TPI	500	110	7.6	WH2020001	FOLDING
20x2.0	50-406	60TPI	550	110	7.6	WH2020002	RIGID
20x2.25	58-406	60TPI	595	110	7.6	WH2022501	FOLDING
20x2.25	58-406	60TPI	645	110	7.6	WH2022502	RIGID

## TAILWHIP IA-2249

SIZE	ETRTO	CASING	WEIGHT	PSI	BAR	PART NO.	BEAD
20x2.125	54-406	60TPI	520	110	7.6	TA2021251	FOLDING
20x2.125	54-406	60TPI	575	110	7.6	TA2021252	RIGID

## MIMOSA IA-2128

SIZE	ETRTO	CASING	WEIGHT	PSI	BAR	PART NO.	BEAD
20x2.0	50-406	60TPI	455	110	7.6	MI2020001	FOLDING
20x2.0	50-406	60TPI	505	110	7.6	MI2020002	RIGID
20x2.20	56-406	60TPI	485	110	7.6	MI2022001	FOLDING
20x2.20	56-406	60TPI	535	110	7.6	MI2022002	RIGID
20x2.30	58-406	60TPI	540	110	7.6	MI2023001	FOLDING
20x2.30	58-406	60TPI	600	110	7.6	MI2023002	RIGID
20x2.40	60-406	60TPI	650	110	7.6	MI2024001	RIGID

BMX TIRE

BMX





**INNOVA TIRE**



Head Office: No.23, Jingcheng  
Rd., Changhua, Taiwan  
TEL: 886-4-8801899.7521037  
E-Mail: [innova@innovatires.com.tw](mailto:innova@innovatires.com.tw)  
FAX: 886-4-7521062  
<http://www.innovatires.com>

